

**Инструкция по сборке**  
**Instructions for assembling furniture**  
**Instrukcja montażu mebli**

Набор мебели для Collection Kolekcja mebli  
общей комнаты «TORINO»

**Шкаф 4DG2S Z**  
**Cupboard 4DG2S Z**  
**Szafa 4DG2S Z**

АН-064.13.00.00

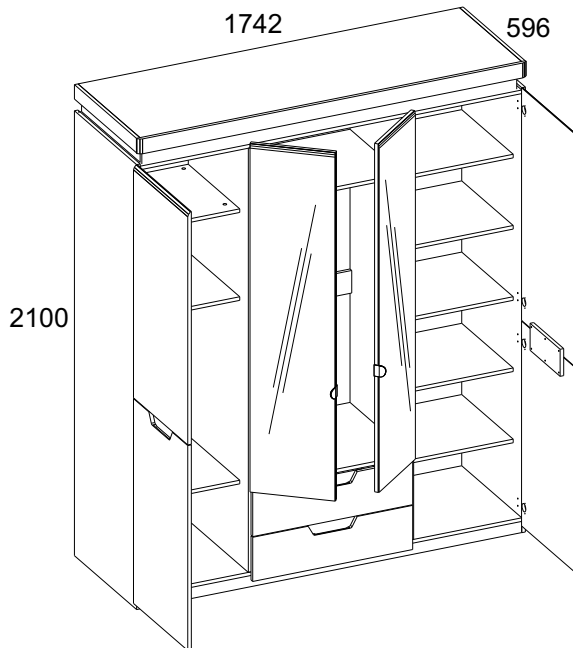

Дата изготовления  
Production date  
Data produkcji

Штамп ОТК  
Stamp of Quality Department  
Pieczęć Działu Jakości

**ИООО “ АНРЭКС ”**

Республика Беларусь, 224004  
г.Брест, ул. Катин Бор, 119  
тел/факс (+375162) 29-74-68



ЕАЭС №BY/112 11.01. TP025 018 05664

от 05.08.2020  
по 04.08.2025

### **Инструкция по эксплуатации.**

Качество и комплектность изделия рекомендуется проверять в магазине при покупке в распакованном виде. Сборка изделия должна производиться в порядке, изложенном в настоящей инструкции. В процессе эксплуатации изделий необходимо периодически затягивать ослабленные винтовые соединения. В случае необходимости перемещения изделия по квартире перед его перестановкой, необходимо полностью освободить его от груза (матраца). Во избежание поломки имеющихся опор передвижение производить приподнимая изделие над уровнем пола. Запрещён прямой контакт с водой. Удаление пыли с изделий следует производить слегка влажной мягкой салфеткой. Во избежание коробления деталей и изменения цвета изделия следует избегать установки мебели на прямых солнечных лучах.

При эксплуатации изделий набора **ЗАПРЕЩАЕТСЯ:**

- устанавливать мебель вблизи отопительных приборов и вплотную к сырým стенам и в помещениях с относительной влажностью более 70%;
- температура нагрева элементов мебели не должна превышать +40 °С.
- в процессе сборки и эксплуатации изделий набора становиться ногами на горизонтальные щиты и витрины;
- применять химические чистящие средства для уборки мебели;

#### **Гарантии изготовителя.**

1. Гарантийный срок эксплуатации изделия - 24 месяца со дня продажи магазином. В период гарантийного срока изготовитель гарантирует ремонт изделий или их замену, если потребителем не нарушены правила эксплуатации.
2. Претензии предъявляются потребителем непосредственно в торгующую организацию, в которой была приобретена мебель, предъявив настоящую "Инструкцию по сборке" и копию товарного чека.
3. Изделие **Шкаф 4DG2S Z**, входящее в состав набора мебели для общей комнаты **«TORINO»**, соответствует требованиям ГОСТ 16371-2014, ТР ТС 025/2012.
4. Срок службы мебели - 5 лет.
5. Предприятие-изготовитель оставляет за собой право вносить изменения в конструкцию изделия, не ухудшая его конструктивные и эксплуатационные характеристики.
6. Для сборки изделий рекомендуется привлекать квалифицированных специалистов.

#### **Запах.**

От новой мебели может исходить запах материалов, из которых она изготовлена. Запах может сохраняться в течение трёх недель с момента сборки. Для снижения интенсивности запаха рекомендуется:

- для мягкой мебели - пропылесосить изделие и проветрить помещение.

Повторять 3-4 раза в день.

- для корпусной мебели – протирать тканью, смоченной мягким моющим средством, вытирать чистой сухой тканью и проветривать помещение, предварительно открывая все двери и ящики изделия.

Повторять 3-4 раза в день.

**Важно!** Сохраните, пожалуйста, инструкцию в случае повторной сборки мебели или рекламации. В случае составления рекламации пользуйтесь, пожалуйста, обозначением из инструкции сборки.

**PL**

### Przy eksploatacji mebli zabrania się:

- ustawiać meble w pobliżu grzewczych przyrządów i obok wilgotnych ścian, a także w pomieszczeniach ze względną wilgotnością więcej niż 70%;
- temperatura nagrzewania elementów mebli nie może przekraczać +40°C;
- w trakcie montażu i eksploatacji mebli stawać nogami na poziome panele i witryny;
- stosować chemiczne środki czyszczące do sprzątania mebli;
- nie należy narażać na kontakt z wodą.

### Gwarancje producenta.

1. Gwarancyjny termin eksploatacji wyrobu - 24 miesiące z dnia sprzedaży. W okresie gwarancyjnego terminu producent gwarantuje naprawę wyrobów lub ich zamianę, jeżeli reguły eksploatacji nie zostały naruszone przez nabywcę.
2. Roszczenia są przekazywane przez nabywcę bezpośrednio do handlującej organizacji, w której były nabyte meble, tylko przy okazaniu danej "Instrukcji montażu" wraz z dokumentem zakupu.
3. Wyrób **Szafa 4DG2S Z**, wchodzący w zestaw mebli "**TORINO**", odpowiada wymaganiom Norm Państwowych 16371-2014, TP TC 025/2012
4. Trwałość użytkowa mebli - 5 lat.
5. Firma-producent pozostawia za sobą prawo do wprowadzania zmian w konstrukcje wyrobów, nie pogarszając ich konstruktywne i eksploatacyjne charakterystyki.
6. Do montażu wyrobów zaleca się skorzystanie z pomocy wykwalifikowanych specjalistów.

### Zapach.

Nowe meble mogą wydzielać zapach materiałów, z których są wykonane. Zapach może utrzymywać się do trzech tygodni od momentu montażu. Aby zmniejszyć intensywność zapachu, zaleca się:

- w przypadku mebli tapicerowanych - odkurzyć produkt i przewietrzyć pomieszczenie.

Powtarzaj 3-4 razy dziennie.

- dla mebli szafkowych - przetrzyj ściereczką zwilżoną łagodnym detergentem, przetrzyj czystą, suchą ściereczką i przewietrz pomieszczenie, uprzednio otwierając wszystkie drzwi i szuflady produktu.

Powtarzaj 3-4 razy dziennie.

**Ważne!** Proszę zachować instrukcję w razie ponownego montażu mebli lub reklamacji. Podczas składania reklamacji prosimy o korzystanie z oznaczeń z instrukcji.

**EN**

### Instruction manual.

It's advised to check the quality and completeness of the product in the store when buying unpacked. Assembling of the product should be done the way it's described in this manual. While the product is in service loose screw connections should be periodically tightened. If it's necessary to move items around the apartment before moving you should release the product completely from the load (the mattress). To prevent damage to existing supports the product should be lifted before moving. Furniture should not be exposed to contact with water. Dusting the product should be done with a slightly damp soft cloth. To prevent warping of parts and discoloration of products do not install furniture in direct sunlight.

### While the product is in service it's PROHIBITED TO:

- Install furniture near heating devices, close to the raw walls and in rooms with a relative humidity of more than 70%;
- heat elements of furniture to the temperature higher +40°C;
- step on the horizontal shields and windows during assembly and use of the products set;
- use chemical cleaners for cleaning furniture;

### Manufacturer's warranty.

1. The warranty period of use of the product - 24 months from the date of sale. During the warranty period the manufacturer guarantees repair or replacement of products, if the user has not violated operating rules.
2. Claims should be made by the consumer directly to the trading organization, in which furniture was purchased, presenting the "Instruction manual" and a copy of the sales receipt.
3. The product **Cupboard 4DG2S Z**, which is part of a set of "**TORINO**", meet the requirements of GOST 16371-2014, TR TS 025/2012.
4. The lifetime of furniture - 5 years.
5. The manufacturer reserves the right to make changes in product design, without compromising its design and application requirements.
6. To assemble the products it's recommended to attract qualified personnel.

### Smell.

New furniture may emit the smell of the materials from which it is made. The smell can persist for up to three weeks from the time of assembly. To reduce odor intensity, it is recommended:

- for upholstered furniture - vacuum the product and ventilate the room.

Repeat 3-4 times a day.

- for cabinet furniture - wipe with a cloth dampened in a mild detergent, wipe with a clean, dry cloth and ventilate the room, previously opening all doors and drawers of the product.

Repeat 3-4 times a day.







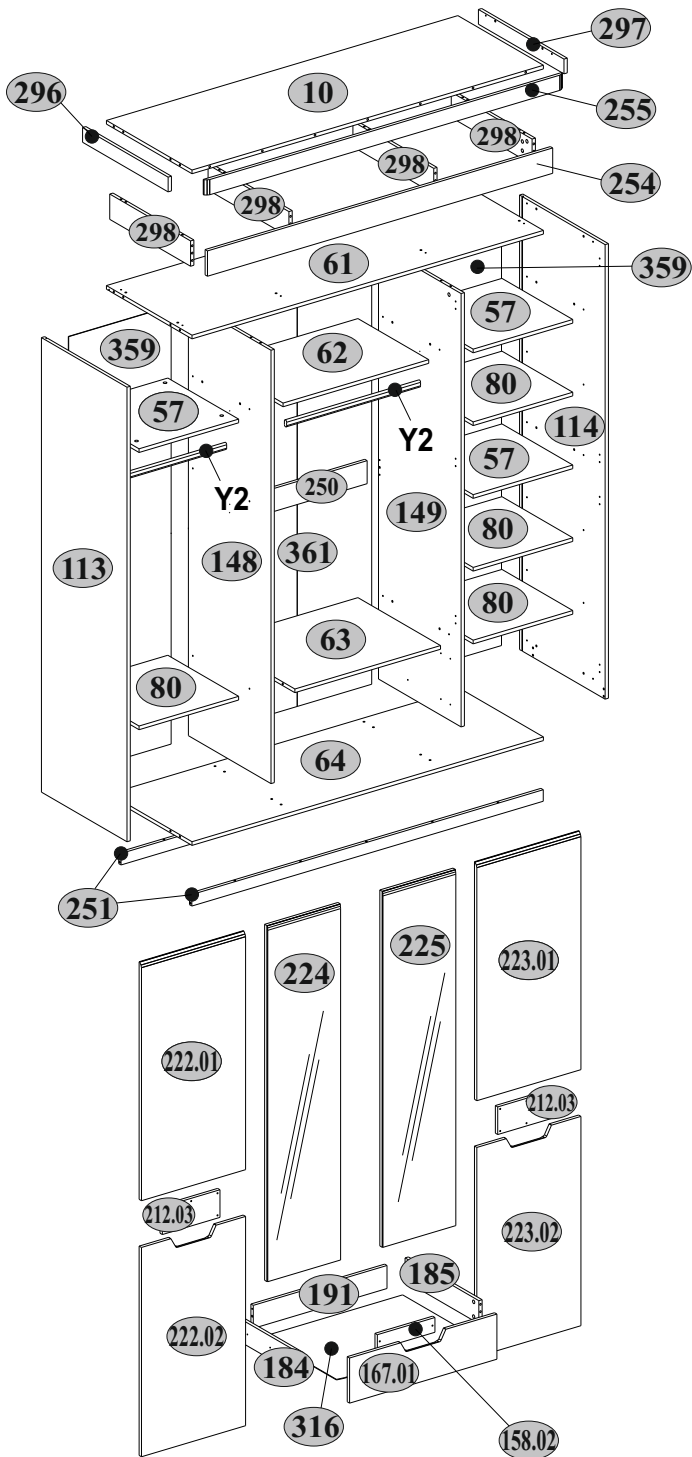

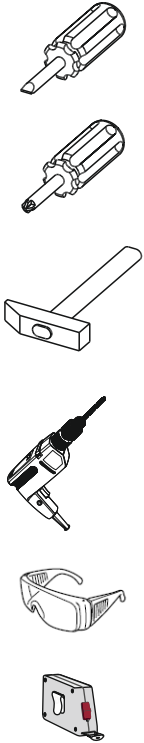



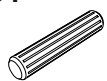
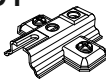
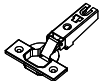
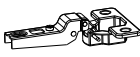
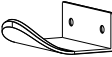

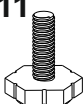

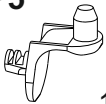

**It is important!** Keep the instruction in case of reassembly of furniture or complaint. When making a claim use the notation from the instruction.

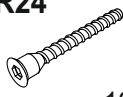
№ п/п	Длина мм	Ширина мм	Толщина мм	Кол-во шт.	№ пачки
10	1708	580	16	1	4/6
61	1708	580	16	1	4/6
57	484	480	16	3	1/6
62	708	480	16	1	1/6
63	708	560	16	1	1/6
64	1708	560	16	1	4/6
80	484	480	16	4	1/6
113	1974	580	16	1	2/6
114	1974	580	16	1	2/6
148	1882	560	16	1	3/6
149	1882	560	16	1	3/6
167.01	716	196	16	2	3/6
158.02	280	64	16	2	3/6
184	500	100	16	2	5/6
185	500	100	16	2	5/6
191	650	100	16	2	1/6
222.01	1032	506	16	1	5/6
222.02	909	506	16	1	5/6
212.03	280	120	16	2	5/6
223.01	1032	506	16	1	5/6
223.02	909	506	16	1	5/6
224	1546	356	20	1	6/6
225	1546	356	20	1	6/6
250	708	100	16	1	1/6
251	1708	50	16	2	3/6
254	1678	110	16	1	3/6
255	1742	66	16	1	3/6
296	580	64	16	1	4/6
297	580	66	16	1	4/6
298	548	110	16	4	5/6
316	680	505	2,5	2	1/6
359	1902	498	2,5	2	2/6
361	1902	724	2,5	1	2/6
Y2	477			1	3/6
Y2	701			1	3/6



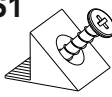
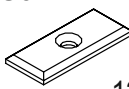



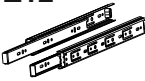

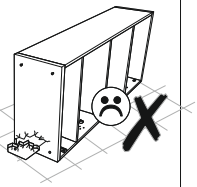
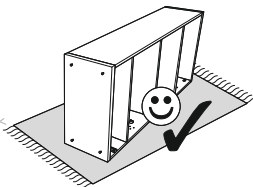
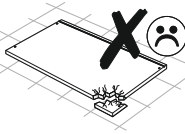
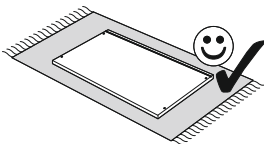
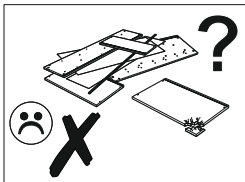
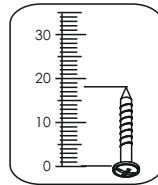
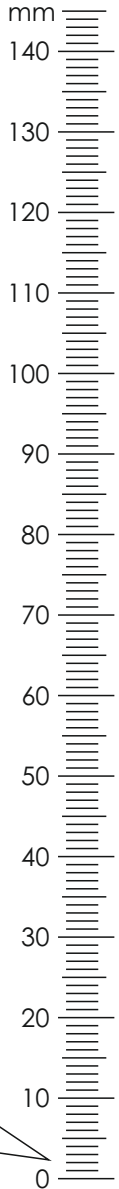

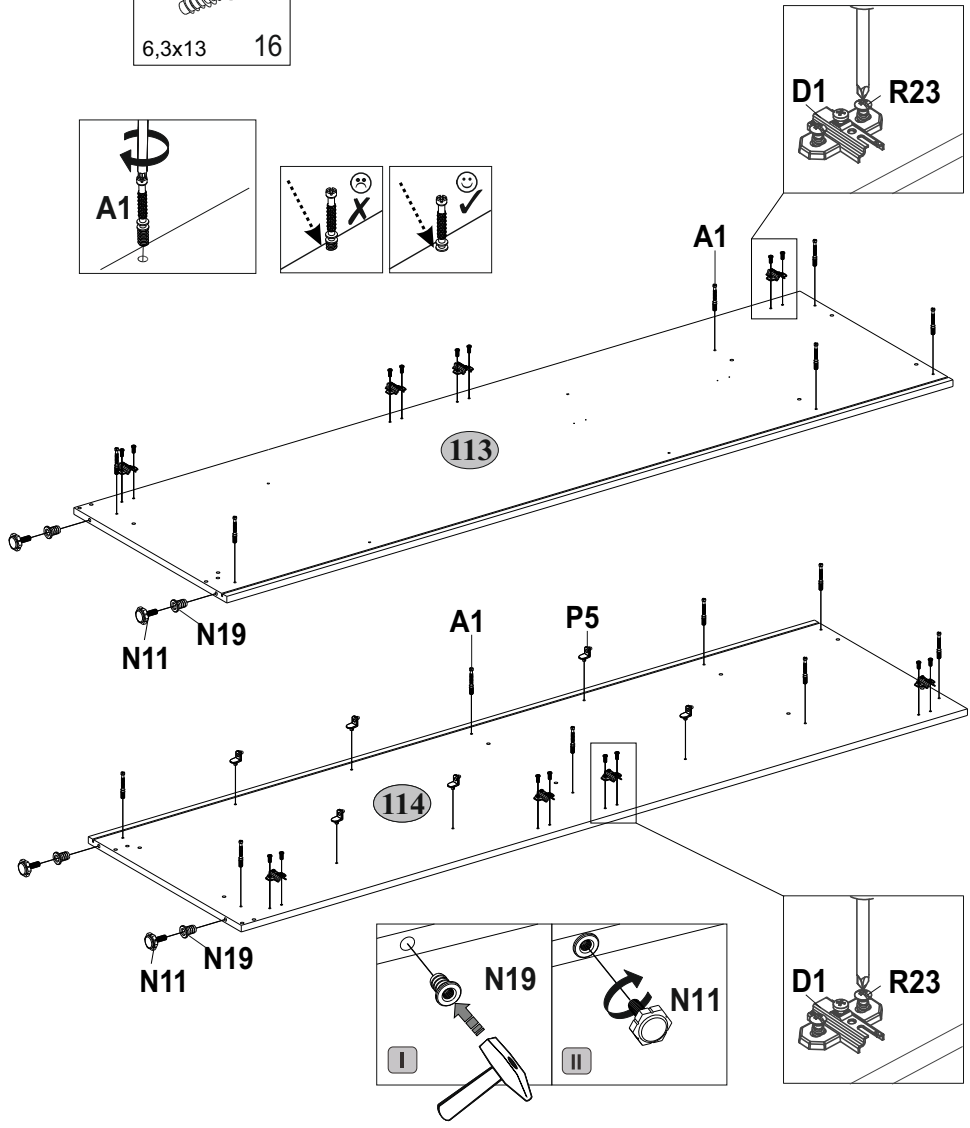
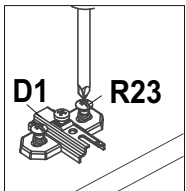
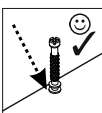
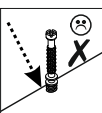
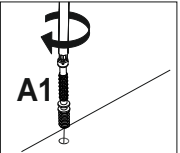
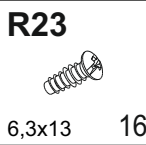
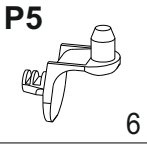
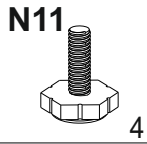
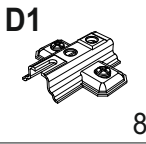
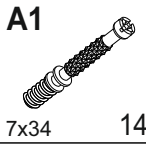

<b>A1</b>  7x34 82	<b>A2</b>  82	<b>B5</b>  10x50 2	<b>C1</b>  8x35 85
<b>D1</b>  14	<b>E1</b>  8	<b>E4</b>  6	<b>H32</b>  2
<b>I</b>  1	<b>L2</b>  500 2	<b>N11</b>  8	<b>N19</b>  8
<b>P5</b>  16	<b>Q</b>  7x1,5 12	<b>R3</b>  3x20 59	<b>R23</b>  6,3x13 28
<b>R24</b>  7x50 12	<b>R27</b>  5,0x13 24	<b>R32</b>  4,0x27 16	<b>R102</b>  3,5x16 52
<b>S1</b>  24	<b>S3</b>  12	<b>S5</b>  Ø18 36	<b>U</b>  90x35x15 2
<b>Y1</b>  4	<b>Z12</b>  400 2		



1

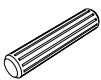
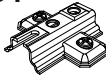



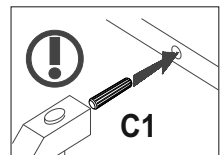
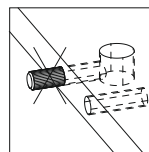
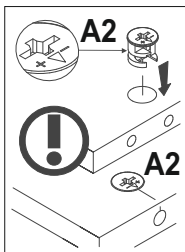
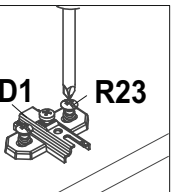
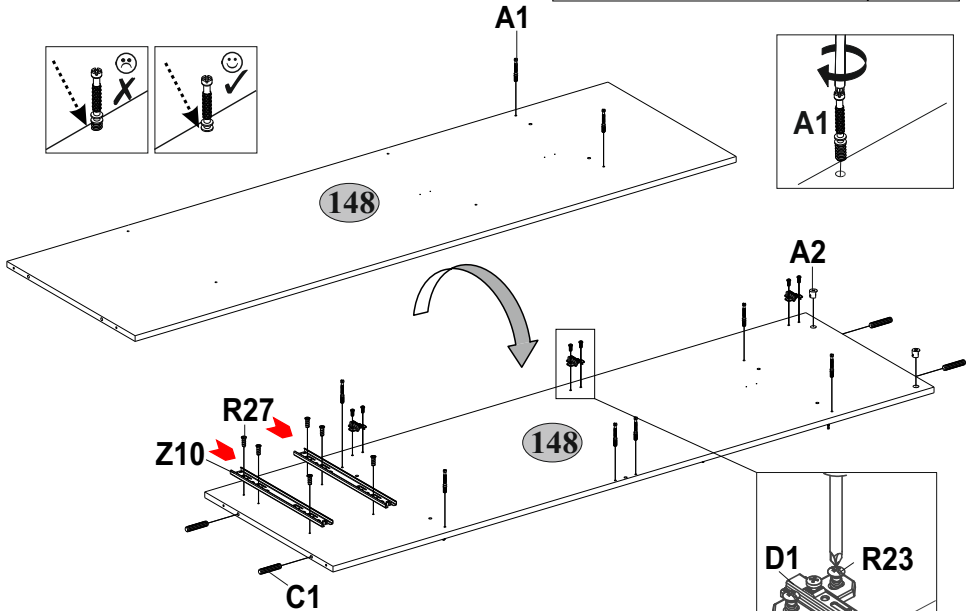
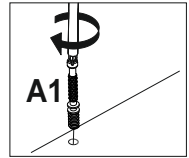
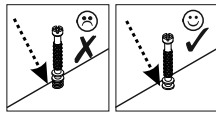
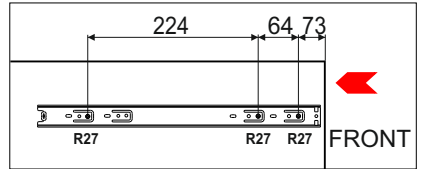
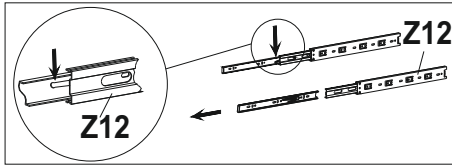

2

<b>A1</b>  7x34 8	<b>A2</b>  2	<b>C1</b>  8x35 4	<b>D1</b>  3	<b>R23</b>  6,3x13 6
<b>R27</b>  5,0x13 6	<b>Z12</b>  400 2			

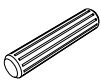
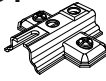
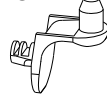

3

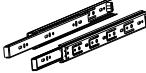
<b>A1</b>  7x34 10	<b>A2</b>  2	<b>C1</b>  8x35 4	<b>D1</b>  3	<b>P5</b>  6
<b>R23</b>  6,3x13 6	<b>R27</b>  5,0x13 6	<b>Z12</b>  400 2		

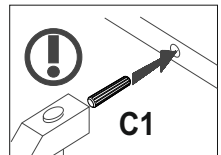
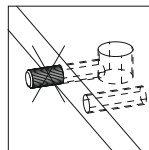
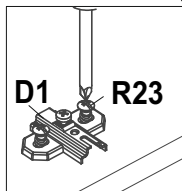
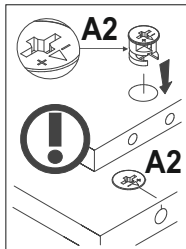
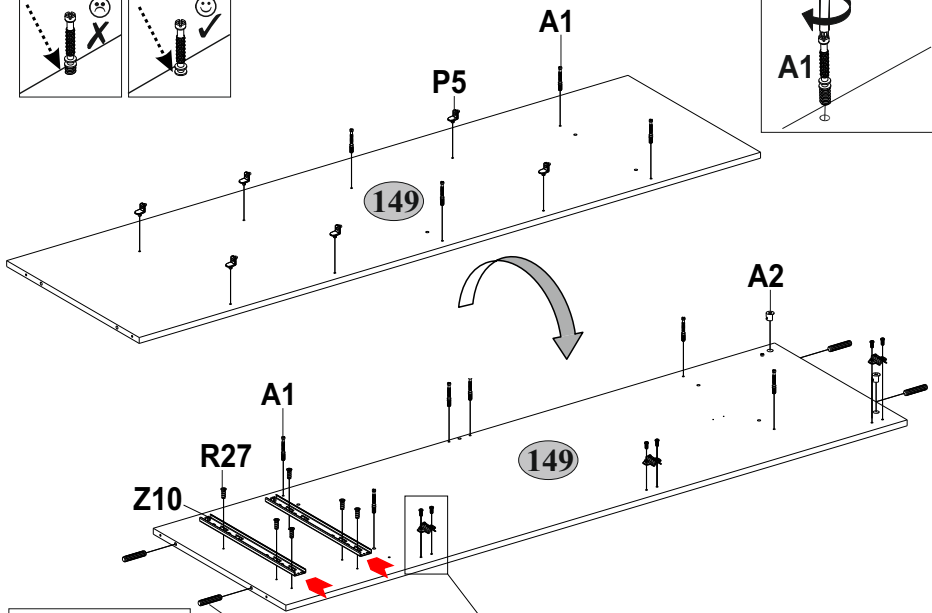
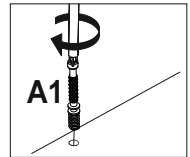
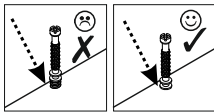
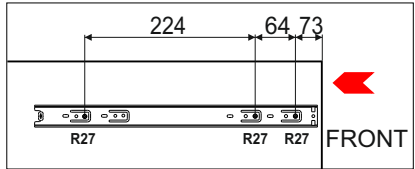
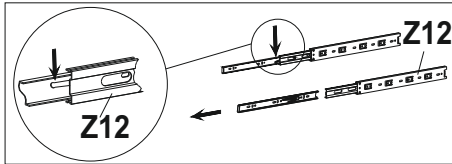

**4**

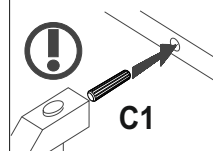
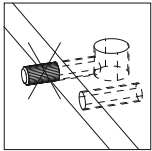
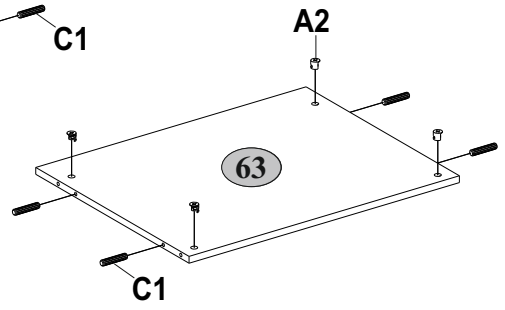
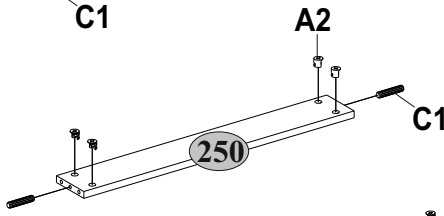
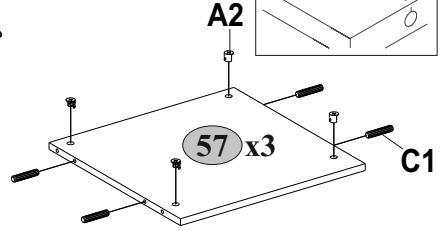
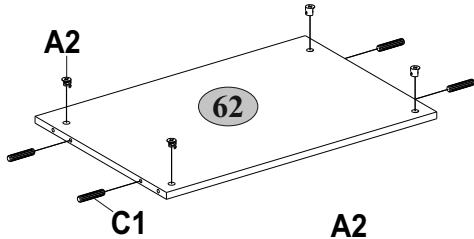
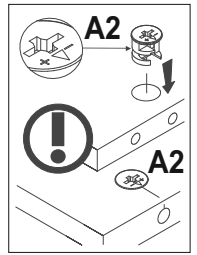
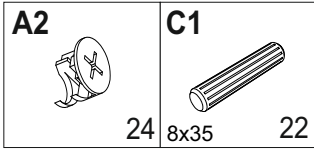

**5**

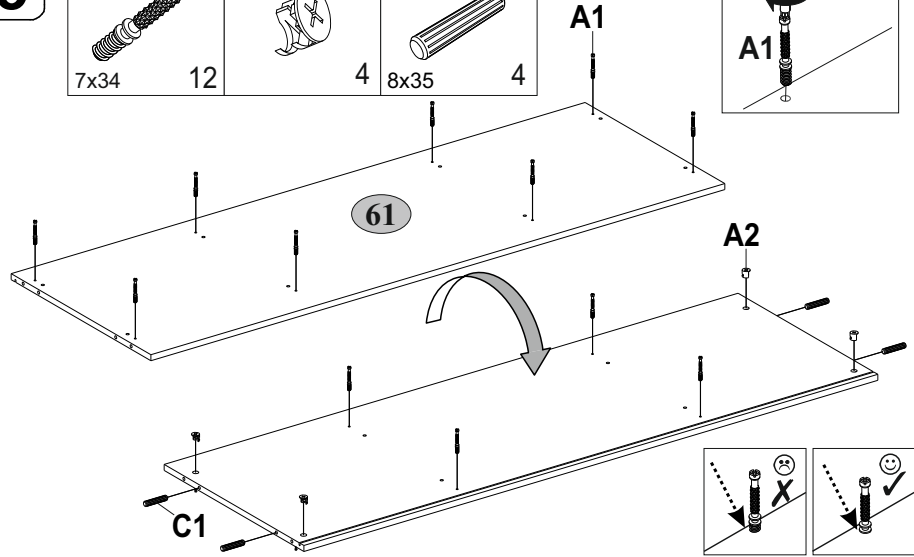
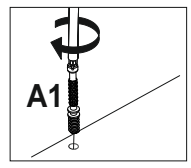
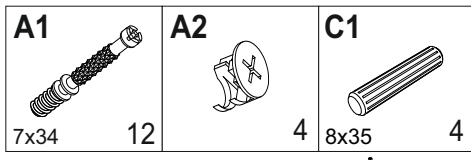

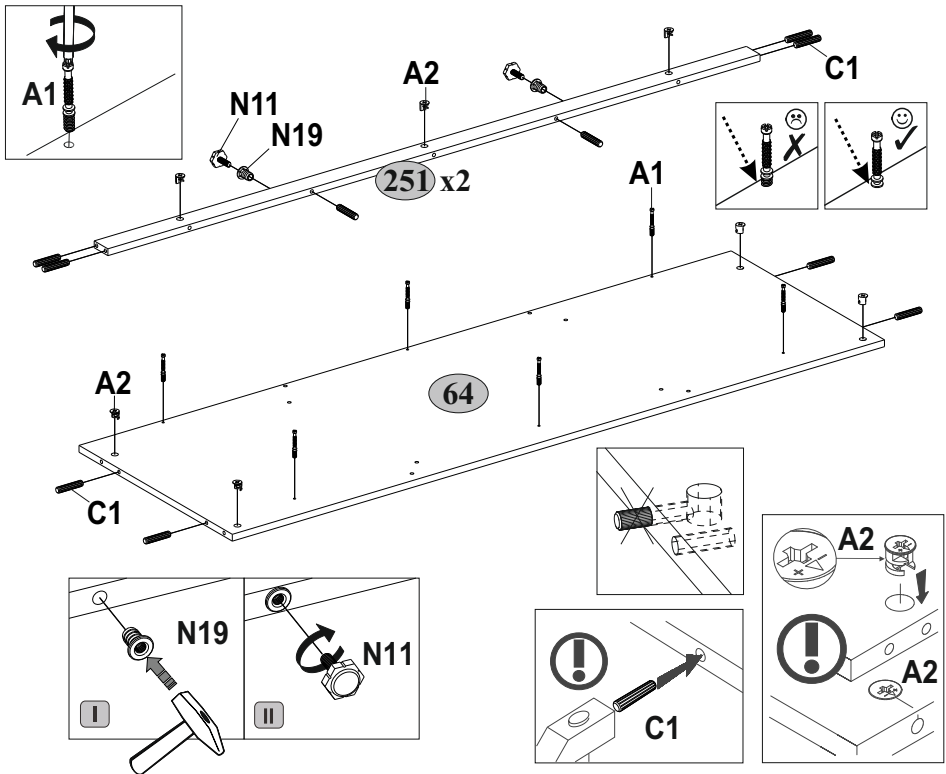
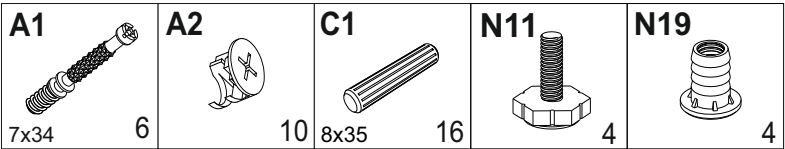
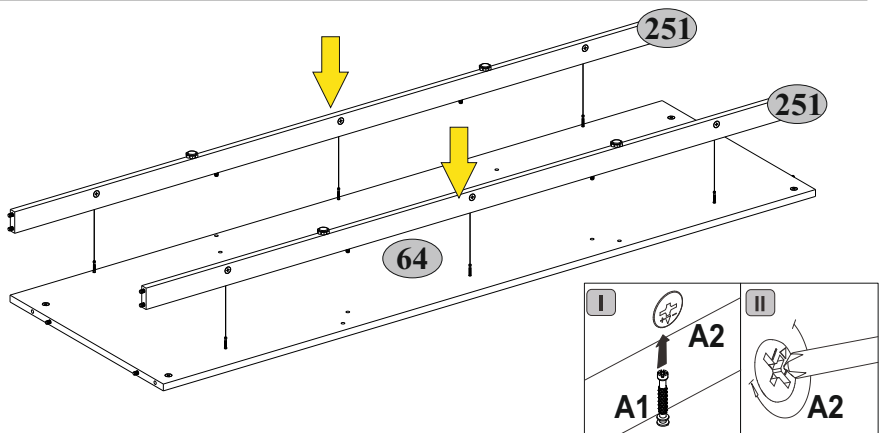
**6****7**

8

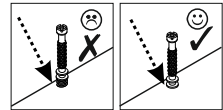
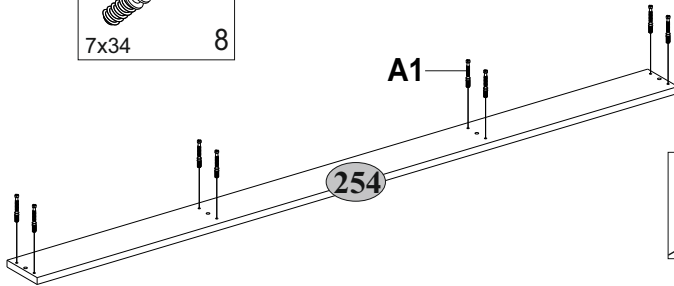
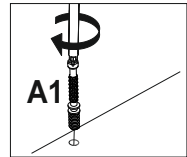
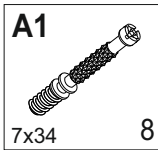

9

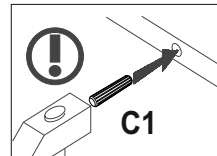
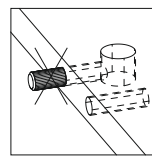
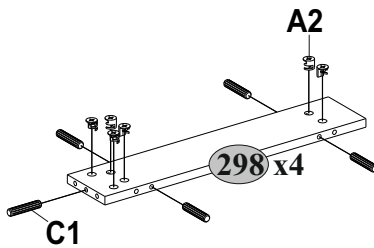
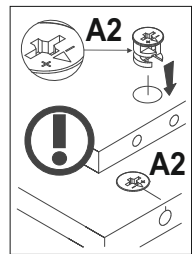
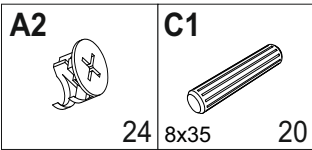

10

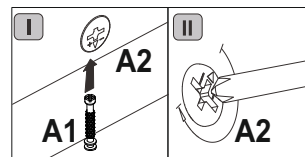
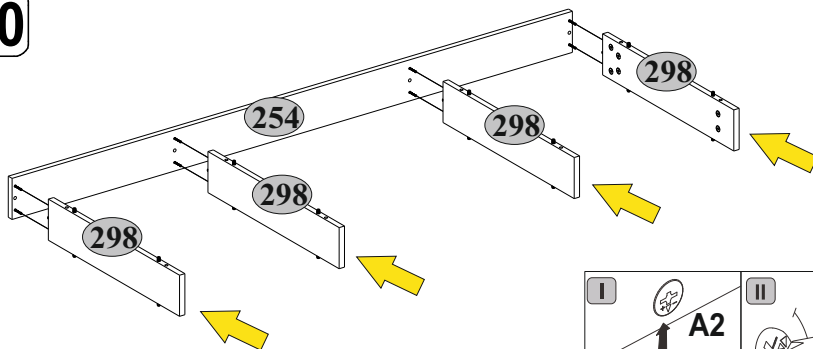

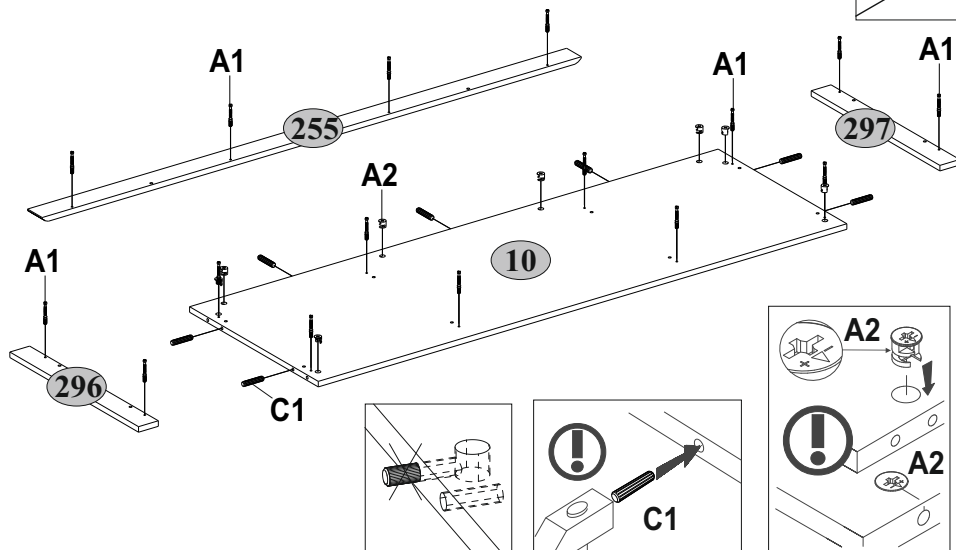
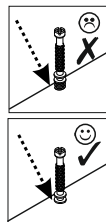
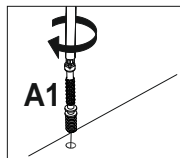
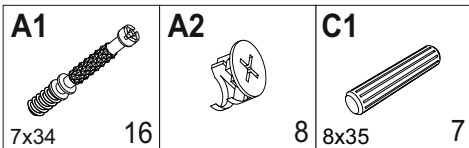
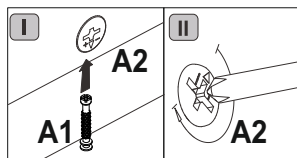
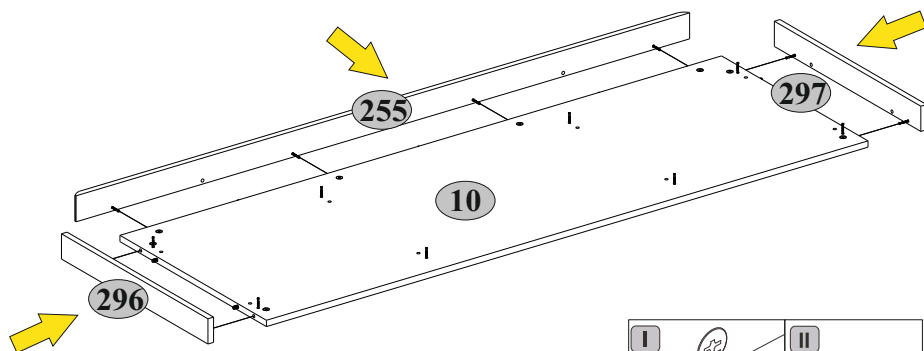

**11****12**

13

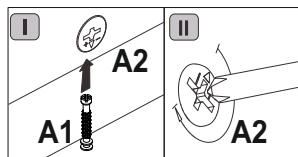
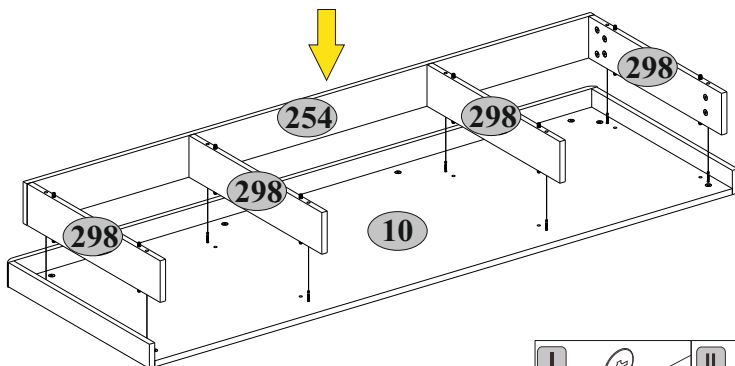

14

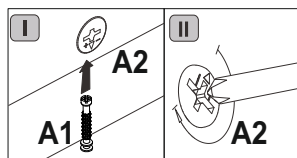
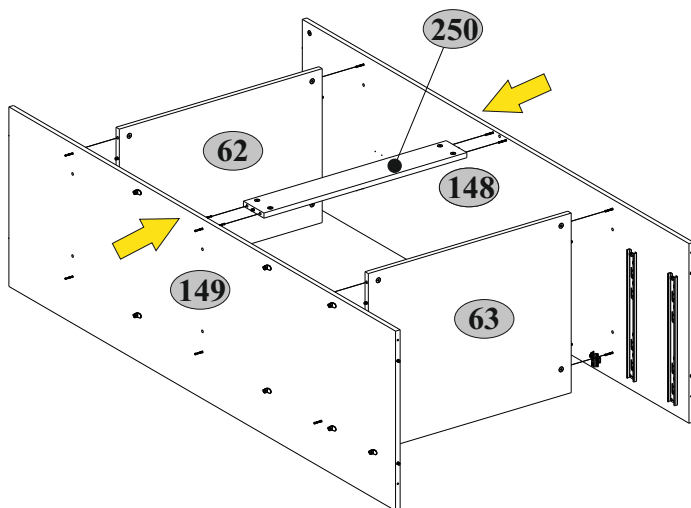

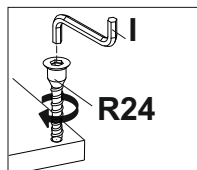
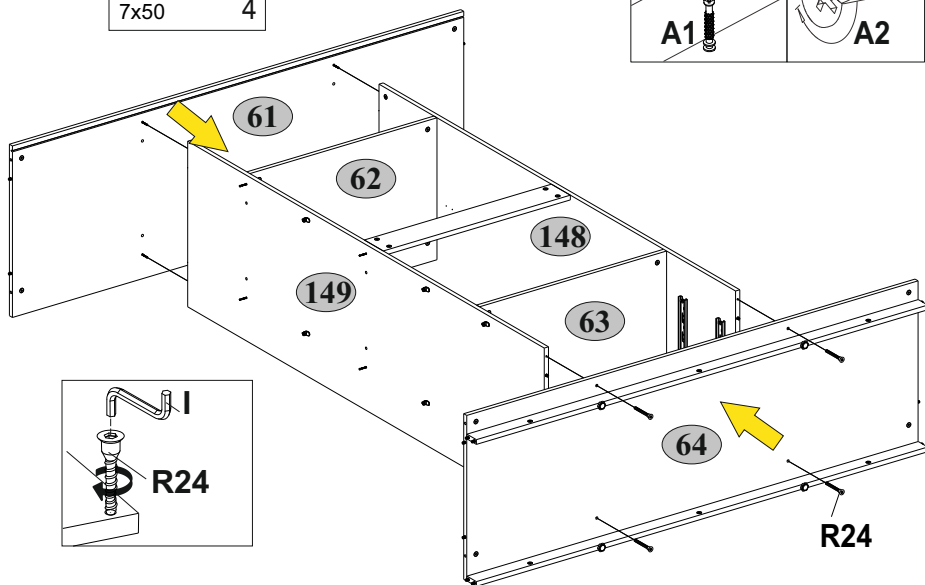
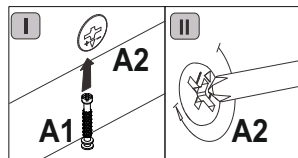
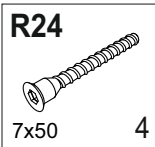

15

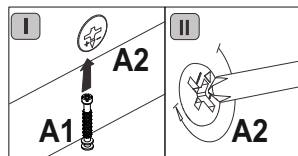
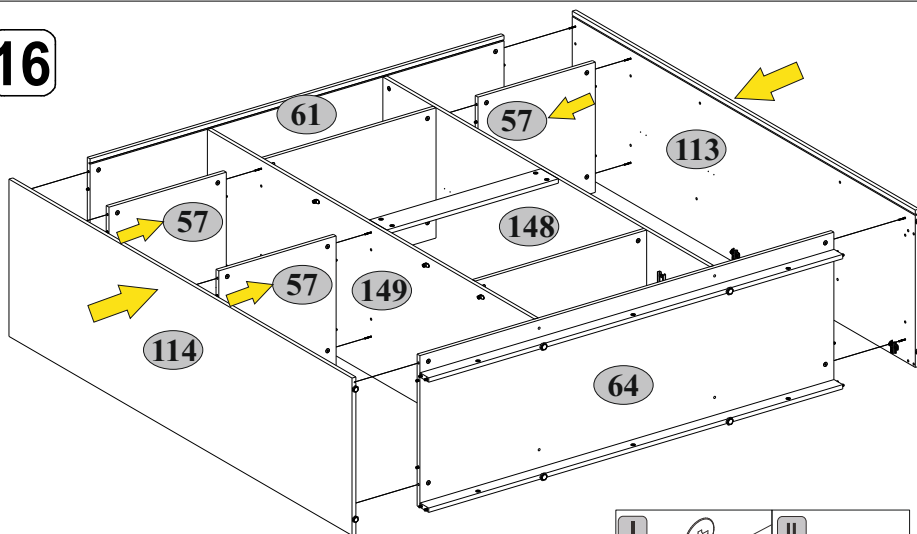

16





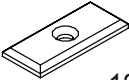

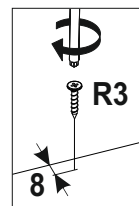
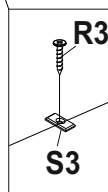
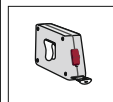
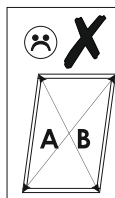
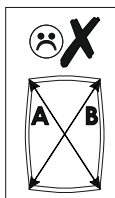
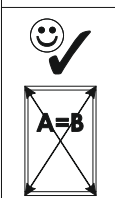
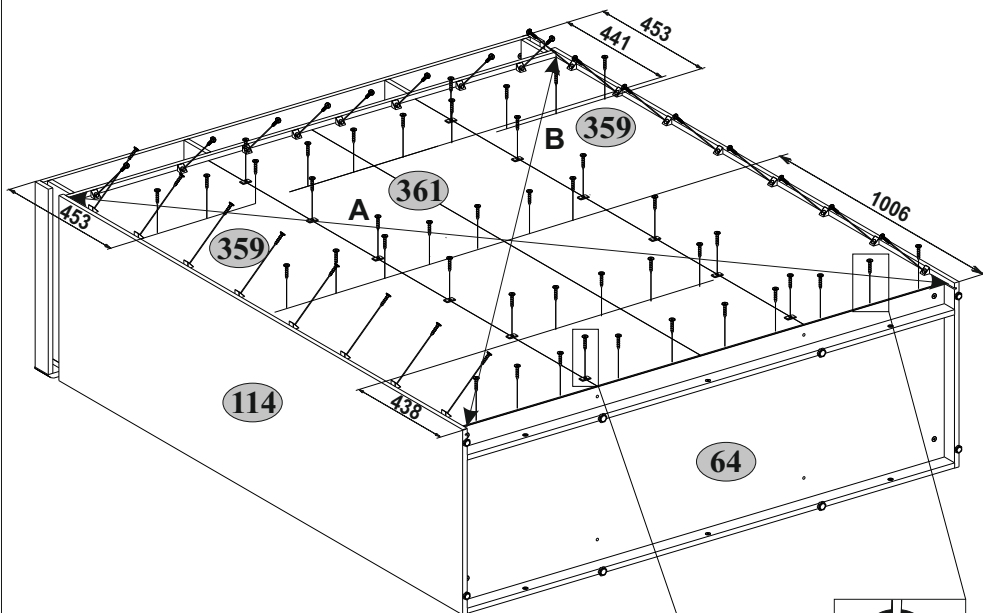
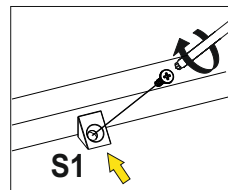
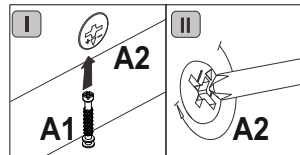
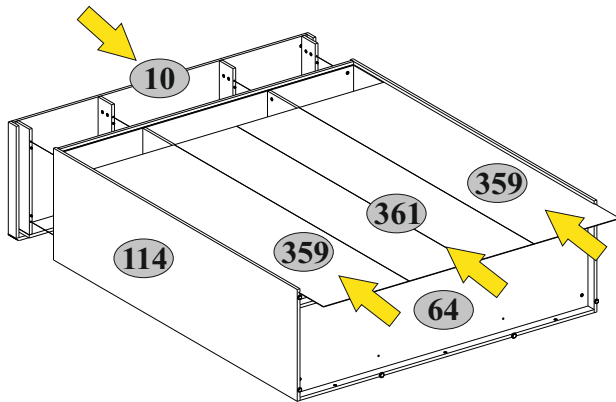

17

<b>R3</b>  3x20    39	<b>R102</b>  3,5x16    4	<b>S1</b>  24	<b>S3</b>  12
--------------------------------------------------------------------------------------------------------------	-----------------------------------------------------------------------------------------------------------------	------------------------------------------------------------------------------------------------------	------------------------------------------------------------------------------------------------------

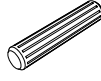

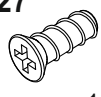

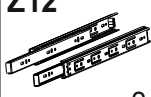
**18****x2**

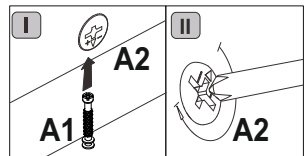
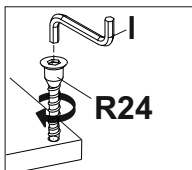
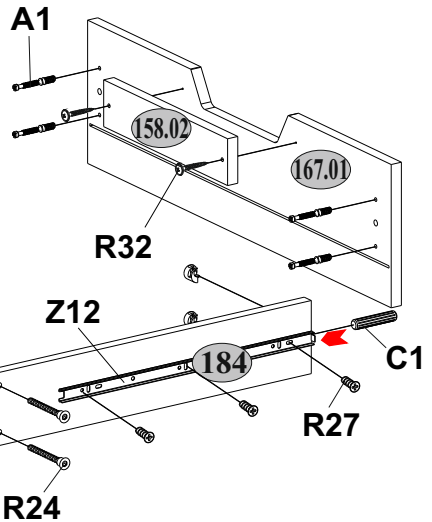
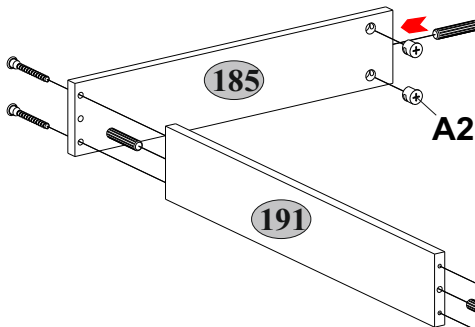
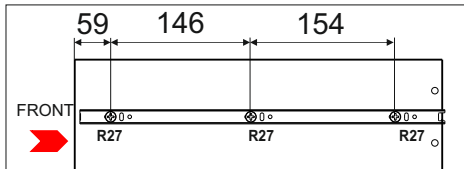
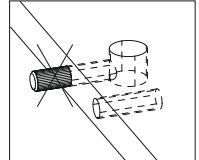
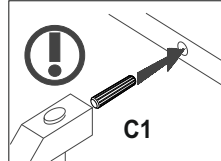
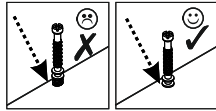
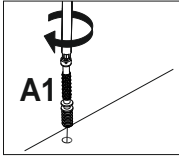
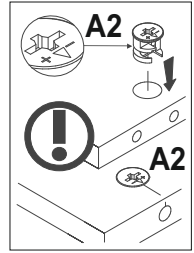

<b>A1</b>  7x34 8	<b>A2</b>  8	<b>C1</b>  8x35 8	<b>I</b>  1
<b>R24</b>  7x50 8	<b>R27</b>  5,0x13 12	<b>R32</b>  4,0x27 4	<b>Z12</b>  400 2



**19****x2**

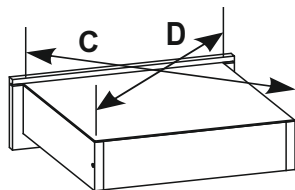
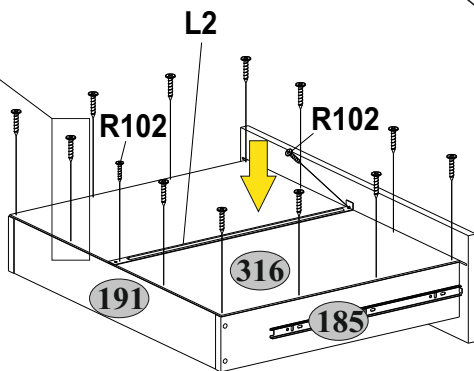
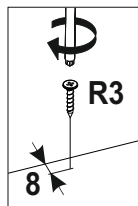

<b>L2</b> 	<b>R3</b> 	<b>R102</b> 
500      2	3x20      20	3,5x16      4

**C=D****20**

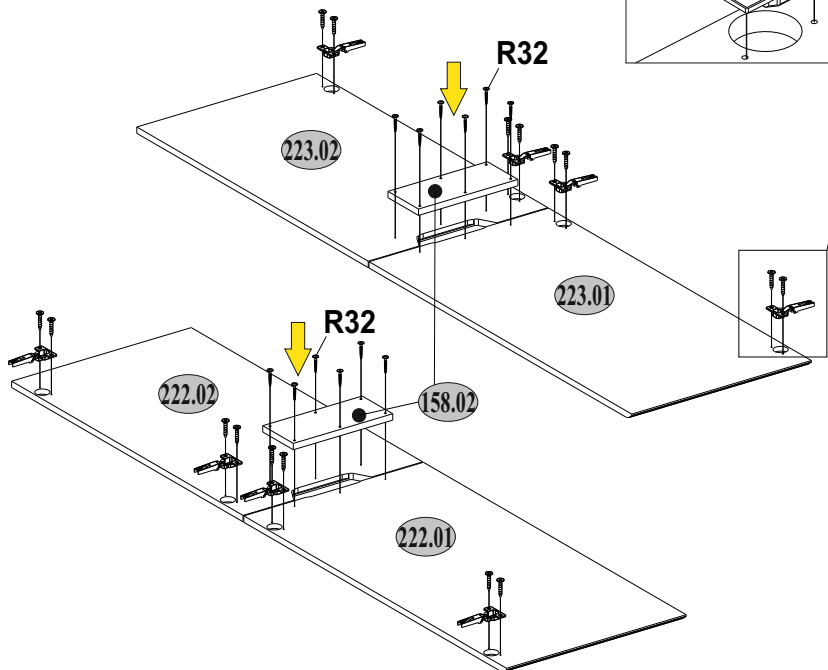
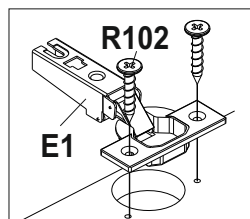
<b>E1</b> 	<b>R32</b> 	<b>R102</b> 
8	4,0x27      12	3,5x16      16





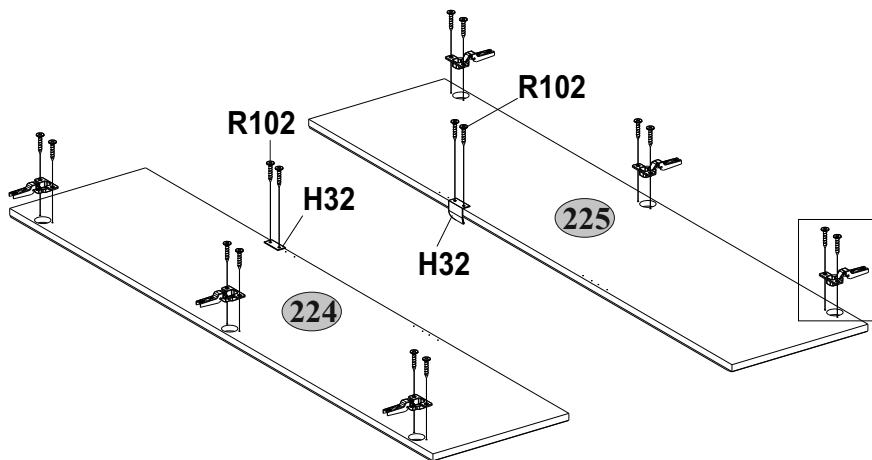
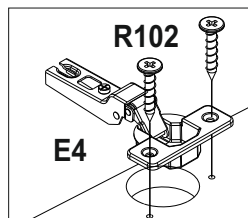

**21**

<b>E4</b>  6	<b>H32</b>  2	<b>R102</b>  3,5x16 16
-----------------------------------------------------------------------------------------------------	------------------------------------------------------------------------------------------------------	---------------------------------------------------------------------------------------------------------------



**22**

<b>P5</b>  4	<b>R102</b>  3,5x16 8	<b>Y1</b>  4
-----------------------------------------------------------------------------------------------------	--------------------------------------------------------------------------------------------------------------	-----------------------------------------------------------------------------------------------------

57 62 63  max. 5 kg

**A**

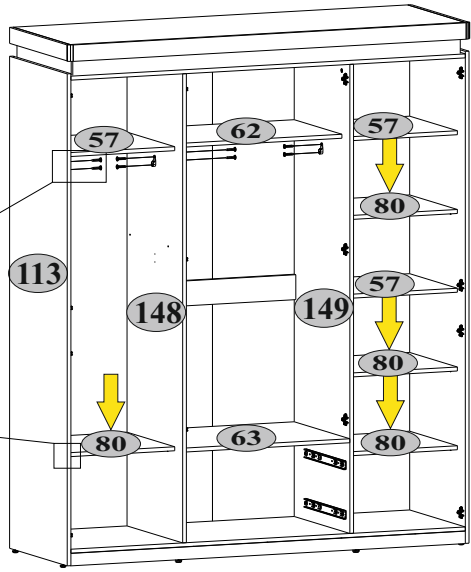
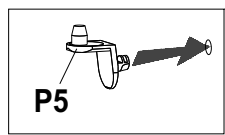
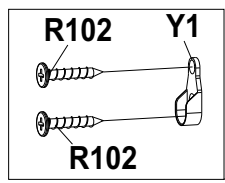

**B**

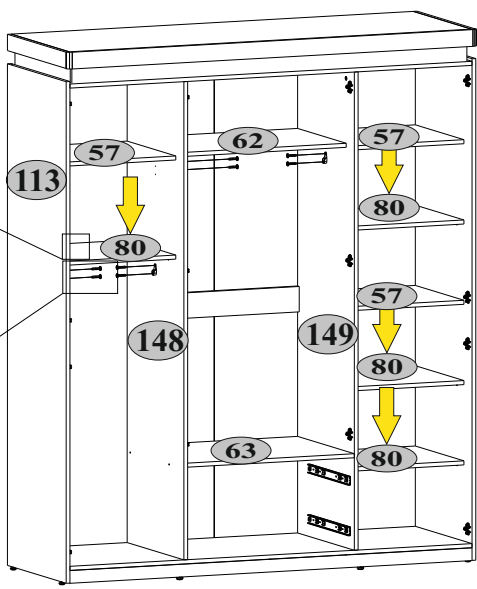
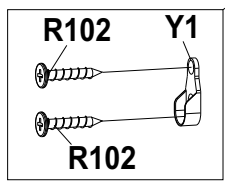
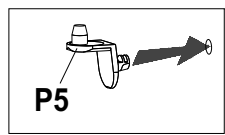

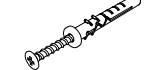

**23****B5**

10x50

2

**Q**

7x1,5

12

**S5**

Ø18

36

**R102**

3,5x16

**U**

4

90x35x15

2

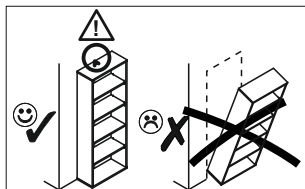
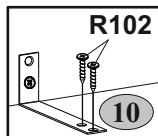
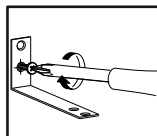
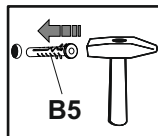
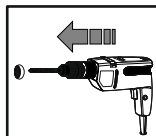
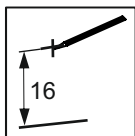
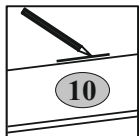
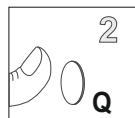
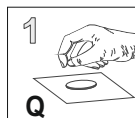
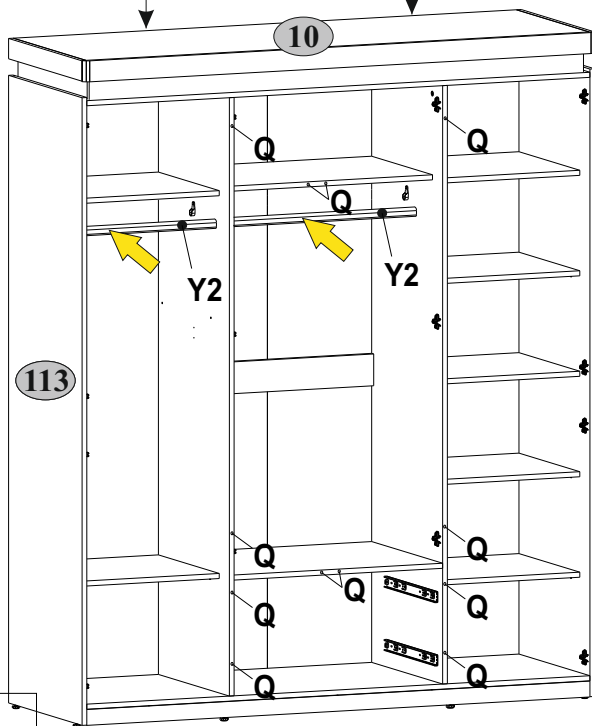
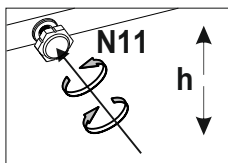
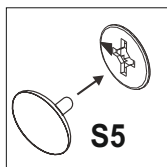
**Y2**max.  
5 kg

24

167.01

max.  
5 kg

10

64

max.  
10 kg

